

COA Series Ceramic SMD LVDS Crystal Oscillator

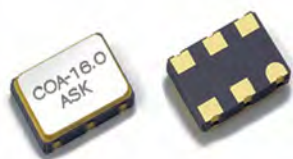

- 7.0x5.0x1.5 hermetically sealed ceramic package
- LVDS Output
- 1.8V, 2.5V, 3.3V supply voltage
- Stability to ± 10 ppm
- Low phase noise
- Tri-state function available



PART NUMBER GUIDE

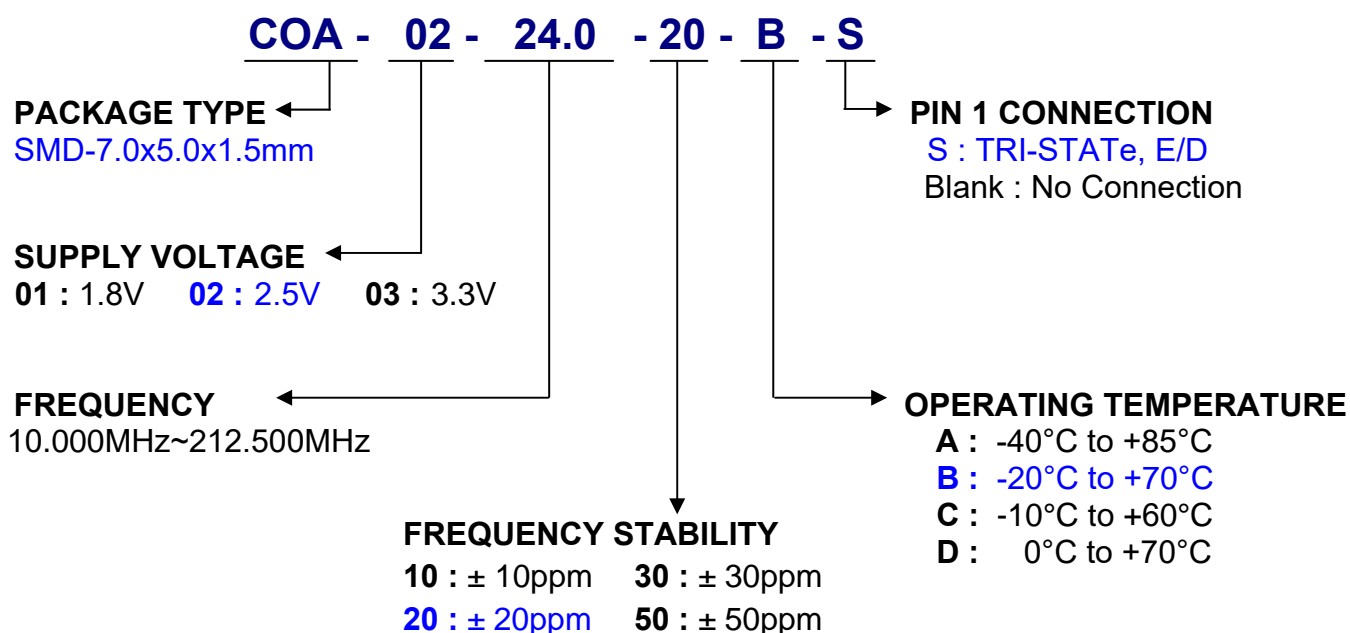

ELECTRICAL SPECIFICATIONS

MODEL	COA-02
Frequency Range	24.000MHz
Frequency Stability*	± 20 ppm
Operating Temperature Range	-40°C ~ +85°C
Storage Temperature Range	-55°C ~ +125°C
Supply Voltage (VDD)	2.5V $\pm 5\%$
Current consumption	50mA Max.
Output Load	100 Ω (between output and complementary output)
Output Voltage Logic High (VOH)	1.6V Max.
Output Voltage Logic Low (VOL)	0.9V Min.
Start up Time	10ms Max.
Rise / Fall Time	1ns Max. (Measured between 20% and 80% of VDD)Output
Output Symmetry	45~55 % (at 50% VDD)
RMS Phase Jitter (integrated 10KHz ~ 20Mhz)	1ps RMS
Aging (at 25°C)	± 3 ppm, 1st Year.

* Overall frequency stability, include 25°C tolerance, operating temperature range, input voltage variation, load change, aging, shock and vibration.

MECHANICAL DIMENSION

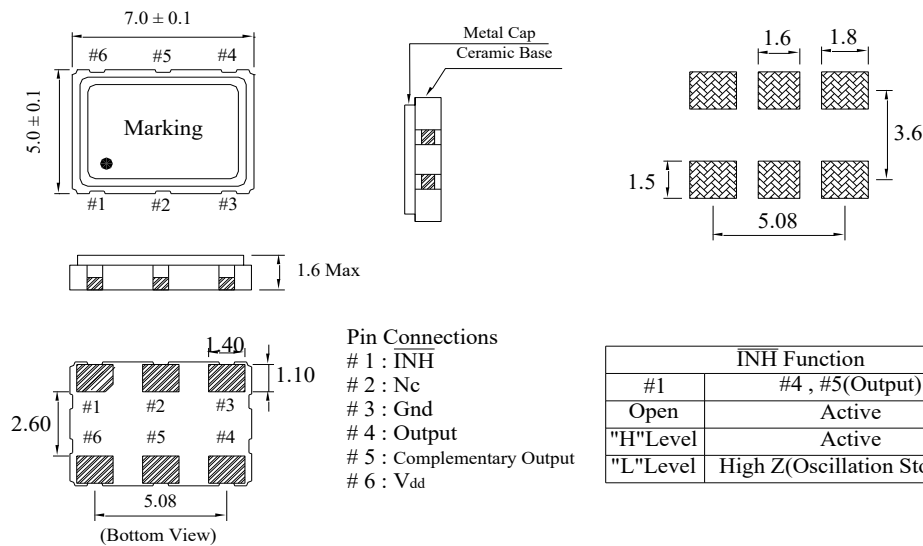

TEST CIRCUIT and OUTPUT WAVEFORMS

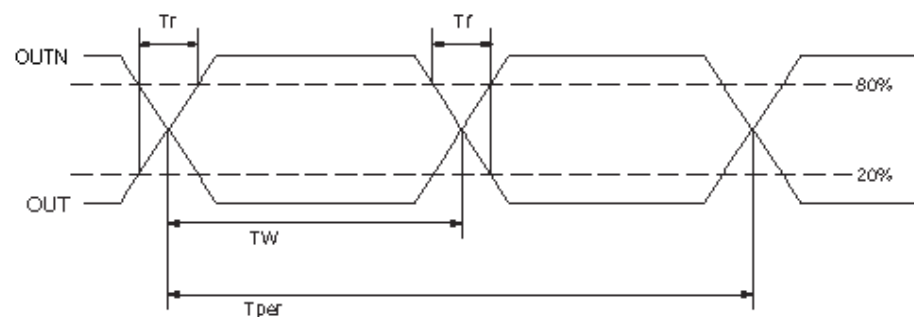
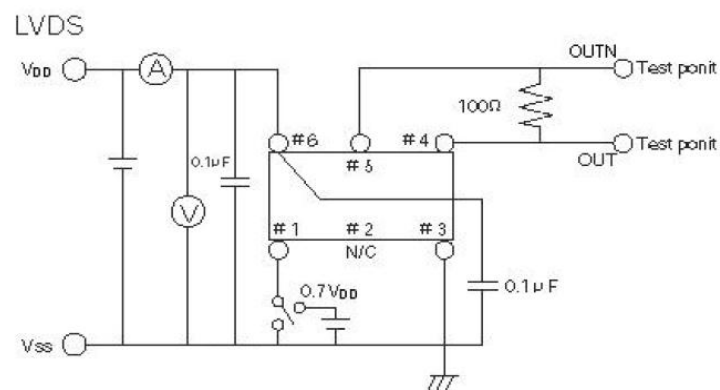

ENVIRONMENTAL SPECIFICATION

Shock	Free Drop from 75cm height on a hard wood board for 3 time
Vibration	10<=>55Hz 1.5mmP-P 1~2min. / CICLE, X.Y.Z 2H for each plane
Aging	85.±3. 720H(NO BIAS)
High Humidity	40.±2. X 90~95% 96H(NO BIAS)
Thermal Cycle	-40.<=>85. 30min X 10 Cycle
Solderability	Mil - STD-202 Method 208

SOLDERING REFLOW

Recommended reflow soldering standard conditions

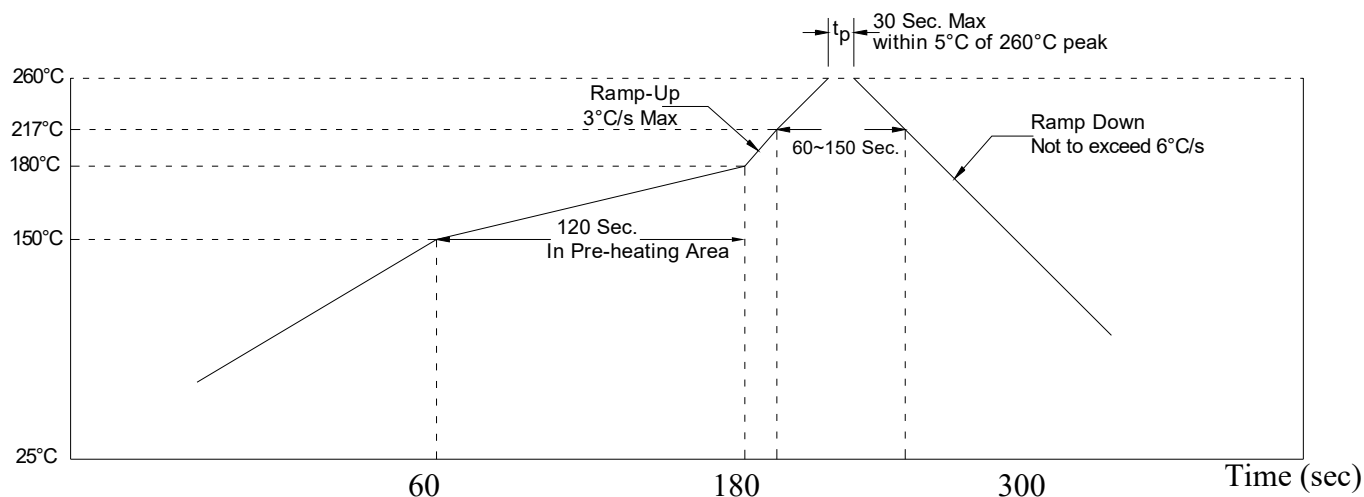

The crystal characteristics may be affected and destroyed at worst by additional production process as ultrasonic welding or molding encapsulation... Please be sure to check if this process affects any damage to crystal products prior to use.

RoHS and REACH Regulation

Product Information

For a product to be **RoHS** compliant, it must satisfy several conditions:

- Contain no more than the specified limits of the target hazardous substances set out in the RoHS Directive
- Able to withstand Pb-free 260°C solder reflow profile
- External packaging and terminations are Pb-free
- Internal PCB, components, solders, and terminations are Pb-free



RoHS 3 Compliance

We certify that our crystal series comply with the European ROHS 3 Directive (EU) 2015/865, Restriction of use of certain Hazardous Substances, which has an effective date of July 22, 2019.

Reach Compliance

EACH Regulation (EC) 1907/2006

Above concerned part is compliant with all requirements in the REACH regulations EC No. 1907/2006.

TAPE & REEL SPECIFICATIONS

Tape Dimensions (unit : mm)

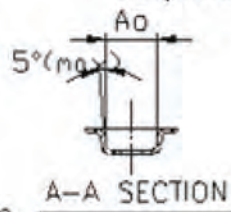
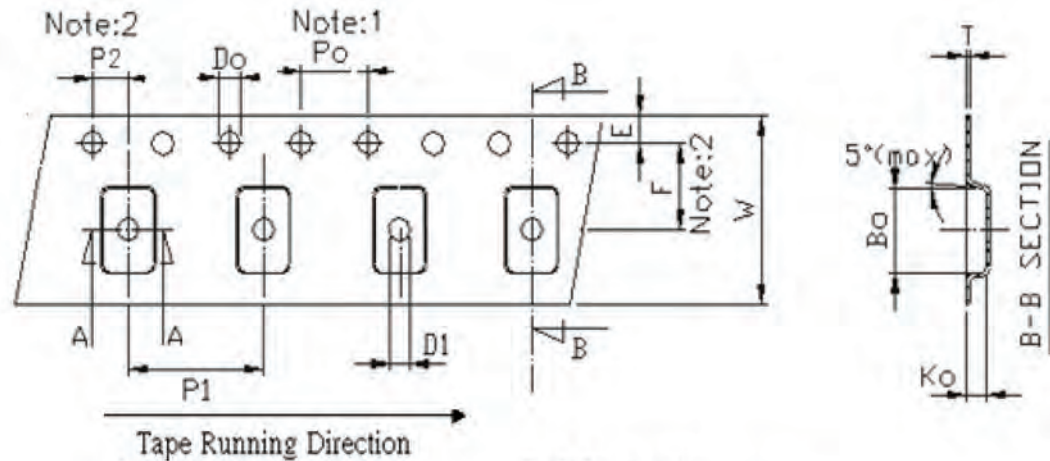

$$A_0 = \frac{5.80 \pm 0.10}{\text{mm}}$$

$$B_0 = \frac{7.70 \pm 0.10}{\text{mm}}$$

$$K_0 = \frac{2.50 \pm 0.10}{\text{mm}}$$

Unit: mm

Symbol	Spec.
K1	-
Po	4.0 ± 0.10
P1	8.0 ± 0.10
P2	2.0 ± 0.05
Do	1.55 ± 0.05
D1	1.50 (MIN)
E	1.75 ± 0.10
F	6.75 ± 0.05
10Po	40.0 ± 0.10
W	16.0 ± 0.20
T	0.30 ± 0.05

Notice:

- 1.10 Sprocket hole pitch cumulative tolerance is ±0.1mm
2. Pocket position relative to sprocket hole measured as true position of pocket not pocket hole.
3. Ao & Bo measured on a plane 0.3mm above the bottom of the pocket to top surface of the carrier.
4. Ko measured from a plane on the inside bottom of the pocket to the top surface of the carrier.
5. Carrier camber shall be not than 1mm per 100mm through a length of 250mm.

TAPE & REEL SPECIFICATIONS

Reel Dimensions (unit : mm)

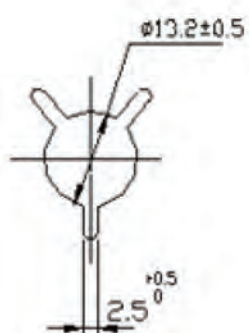
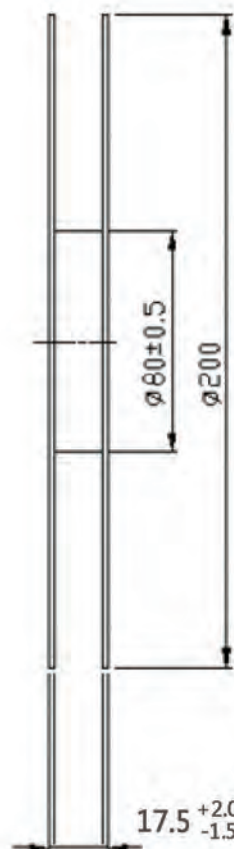
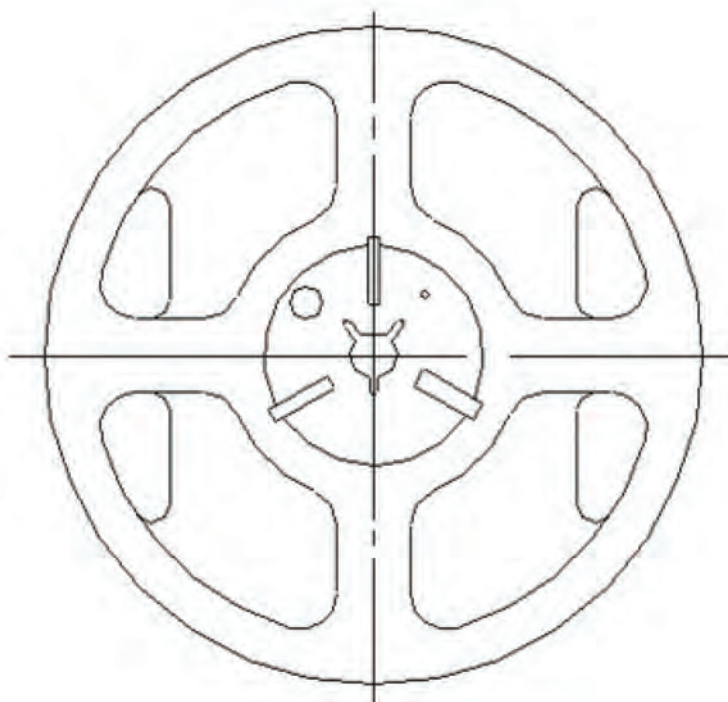

Unit:mm

Qty:3000pcs/reel