

COY Series Ceramic SMD Oscillator

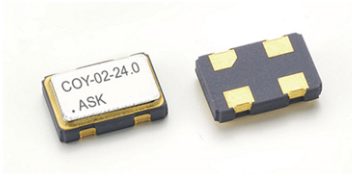

- Ceramic SMD package
- 1.8V to 5.0V supply voltage
- HCMOS/TTL Output
- Stability to $\pm 10\text{ppm}$
- Suitable for reflow soldering

PART NUMBER GUIDE

COY-02 - 10.0 - 20 - B - S

PACKAGE TYPE

- COY-05 : SMD - 5.0x3.2x1.2mm (5.0V)
- COY-03 : SMD - 5.0x3.2x1.2mm (3.3V)
- COY-03A : SMD - 5.0x3.2x1.2mm (3.0V)
- COY-03M : SMD - 5.0x3.2x1.2mm (1.8V ~3.3V)
- COY-02 : SMD - 5.0x3.2x1.2mm (2.5V)**
- COY-02A : SMD - 5.0x3.2x1.2mm (2.8V)
- COY-01 : SMD - 5.0x3.2x1.2mm (1.8V)

FREQUENCY

1.000MHz~156.000MHz

FREQUENCY STABILITY

20 : $\pm 20\text{ppm}$

PIN 1 CONNECTION

S : TRI-STATE, E/D
Blank : No Connection

OPERATING TEMPERATURE

A : -40°C to $+85^{\circ}\text{C}$
B : -20°C to $+70^{\circ}\text{C}$
C : -10°C to $+70^{\circ}\text{C}$
D : 0°C to $+70^{\circ}\text{C}$

ELECTRICAL SPECIFICATIONS

MODEL	COY-02
Frequency Range	10.000MHz (AT Cut, Fundamental)
Frequency Tolerance / Stability	$\pm 20\text{ppm}$
Operating Temperature Range	-20°C to $+70^{\circ}\text{C}$
Storage Temperature Range	-55°C to $+125^{\circ}\text{C}$
Supply Voltage (VDD)	2.5V $\pm 5\%$
Current consumption	8mA Max.
Load	15pf
Output Level	CMOS
Output Voltage Logic High (VOH)	0.9VDD Min.
Output Voltage Logic Low (VOL)	0.1VDD Max.
Start up Time	5ms Max.
Rise / Fall Time	5ns Max.
Output Symmetry	45~55 % (at 50% VDD)
Phase jitter (integrated 10KHz ~ 20Mhz)	1ps RMS
Peak to peak jitter	50ps Max.
Aging (at 25°C)	$\pm 3\text{ppm/ year}$ Max.
Min. Packing	1000pcs/ Reel

MECHANICAL DIMENSION

COY

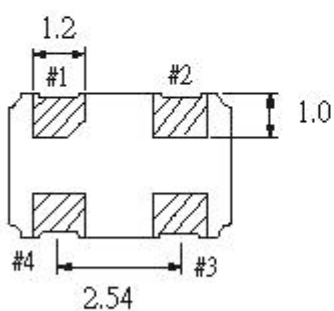
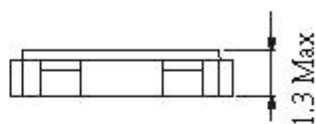
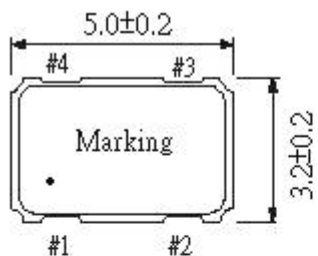

Pin Assignment

- #1 STANDBY CON
- #2 GND
- #3 OUTPUT
- #4 VDD

Pin 1	Output
H/Floating	Enable
L	Standby

TEST CIRCUIT

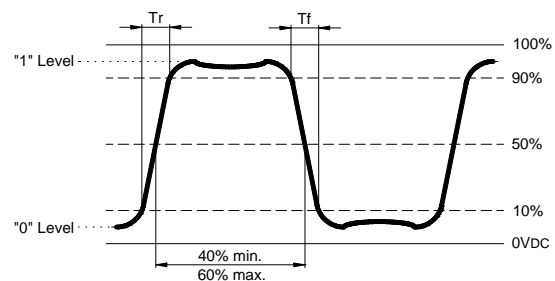
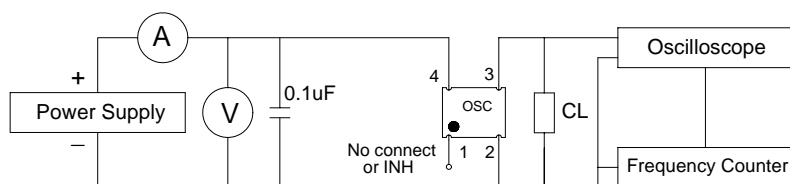

SPECIFICATION OF CRYSTAL OSCILLATOR

Soldering reflow

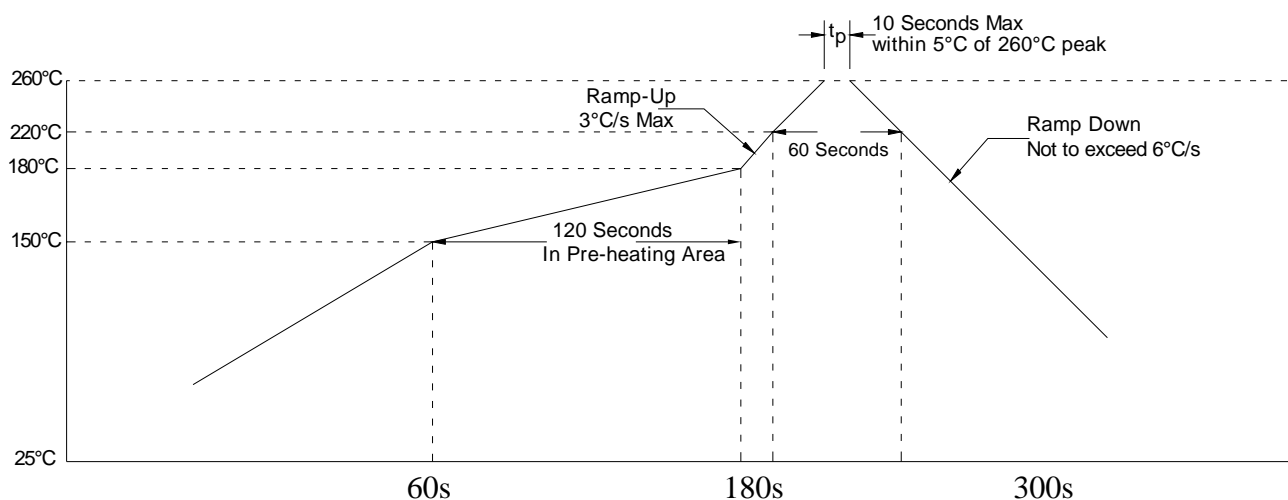

Pb-free compliance

Component and Assembly Pb content shall be less than 0.1% by weight of the device (in accordance with IPC/EIA J-STD-006, European ROHS 3 Directive (EU) 2015/865).

Product Information

For a product to be **RoHS** compliant, it must satisfy several conditions:

- Contain no more than the specified limits of the target hazardous substances set out in the RoHS Directive
- Able to withstand Pb-free 260°C solder reflow profile below
- External packaging and terminations are Pb-free
- Internal PCB, components, solders, and terminations are Pb-free

EACH Regulation (EC) 1907/2006

Above concerned part is compliant with all requirement in the REACH regulations EC No. 1907/2006.

SPECIFICATION OF CRYSTAL OSCILLATOR
--

Reliability Test (applicable to OSC and SMD type X'tal)

Test Items	Test Condition	Specification	
		General OSC (Note:1)	General X' tal (Note:2)
1. Gross Leak Test	FC-40 125°C/30sec	No continuous bubble	
2. Fine Leak Test	Bombing of He 5kg/cm ² for 2 hours	Less than 1*10 ⁻⁸ atm.c.c./sec, Helium	
3. Drop Test	Free dropped a. ~19.999MHz(Fund.) →100 cm height b. 20~29.999MHz(Fund.) →50 cm height c. 30~ MHz(Fund.) →20 cm height on a hard wooden board for 3 times (board is thickness more than 30 mm)	$\Delta F \leq \pm 10\text{PPM}$, Duty within spec.	$\Delta F \leq \pm 10\text{PPM}$, $\Delta C.I. \leq \pm 10\text{ohms}$
4. Vibration Test	Freq. range: 10~55Hz Peak to peak amplitude:1.5mm Peak acceleration:10 G 3 direction(X,Y,Z) , each 60min.	$\Delta F \leq \pm 10\text{PPM}$, Duty within spec.	$\Delta F \leq \pm 10\text{PPM}$, $\Delta C.I. \leq \pm 10\text{ohms}$
5. Resistance to Soldering Test	a. IR Reflow furnace with the condition 2 times. Peak temp. 260±3°C , 10sec(Min.)	$\Delta F \leq \pm 10\text{PPM}$, Duty within spec. For SMD OSC only	$\Delta F \leq \pm 10\text{PPM}$, $\Delta C.I. \leq \pm 10\text{ohms}$
	b. Dip terminals in a 260±5°C solder bath for 5±0.5 sec.	At least 90% of each dipped area shall be covered by fresh solder. For DIP OSC only.	NA
6. Bending Test	Bending cycle : 1 cycle 0° -> 45° -> 0° -> 45° -> 0°	$\Delta F \leq \pm 5\text{PPM}$, Duty within spec. For DIP OSC only.	NA
7. Share Test	Weight : 10N, Test duration : 10±1 sec	$\Delta F \leq \pm 5\text{PPM}$, Duty within spec. For SMD OSC only.	$\Delta F \leq \pm 10\text{PPM}$, $\Delta C.I. \leq \pm 10\text{ohms}$
8. Low Temp. Exposure Test	-40±3°C, 240±12 hrs	$\Delta F \leq \pm 10\text{PPM}$, Duty within spec.	$\Delta F \leq \pm 10\text{PPM}$, $\Delta C.I. \leq \pm 10\text{ohms}$
9. Aging Test	125±3°C, 240±12hrs	$\Delta F \leq \pm 10\text{PPM}$, Duty within spec.	$\Delta F \leq \pm 10\text{PPM}$, $\Delta C.I. \leq \pm 10\text{ohms}$
10. High Temp. & Humidity Test	+85°C±5°C & 85%±5% R.H. , 240±12 hrs	$\Delta F \leq \pm 10\text{PPM}$, Duty within spec.	$\Delta F \leq \pm 10\text{PPM}$, $\Delta C.I. \leq \pm 10\text{ohms}$
11. Temperature Cycling Test	-40±3°C/15±3min ~ +85±3°C/15±3min 15cycles	$\Delta F \leq \pm 10\text{PPM}$, Duty within spec.	$\Delta F \leq \pm 10\text{PPM}$, $\Delta C.I. \leq \pm 10\text{ohms}$

Note:1 → For communication application the spec. demanded " $\Delta F \leq \pm 5\text{ PPM}$, Duty within spec." .

Note:2 → For communication application the spec. demanded " $\Delta F \leq \pm 5\text{ PPM}$, $\Delta C.I. \leq \pm 5\text{ ohms}$ " .

SPECIFICATION OF TAPE & REEL

Taping

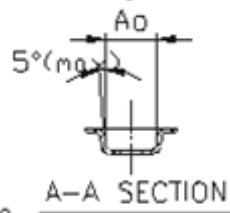
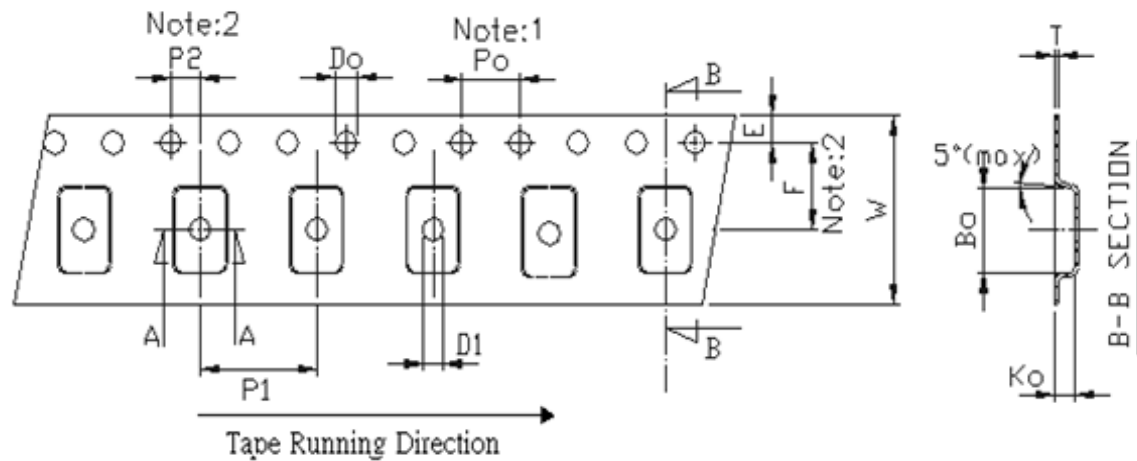

$$A_0 = \underline{3.50 \pm 0.10} \text{ mm}$$

$$B_0 = \underline{5.25 \pm 0.10} \text{ mm}$$

$$K_0 = \underline{1.40 \pm 0.10} \text{ mm}$$

Unit: mm

Symbol	Spec.
K1	-
Po	4.0 ± 0.10
P1	8.0 ± 0.10
P2	2.0 ± 0.05
Do	1.55 ± 0.05
D1	1.50(MIN)
E	1.75 ± 0.10
F	5.50 ± 0.05
10Po	40.0 ± 0.10
W	12.0 ± 0.20
T	0.30 ± 0.05

Notice:

- 1.10 Sprocket hole pitch cumulative tolerance is ±0.1mm
2. Pocket position relative to sprocket hole measured as true position of pocket not pocket hole.
3. Ao & Bo measured on a plane 0.3mm above the bottom of the pocket to top surface of the carrier.
4. Ko measured from a plane on the inside bottom of the pocket to the top surface of the carrier.
5. Carrier camber shall be not than 1mm per 100mm through a length of 250mm.

SPECIFICATION OF TAPE & REEL

Reel

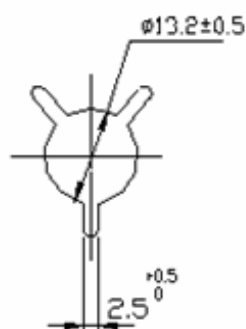
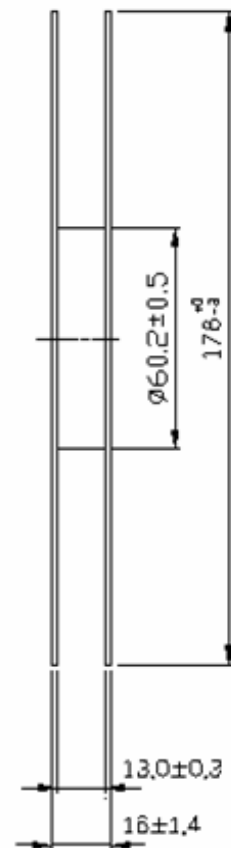
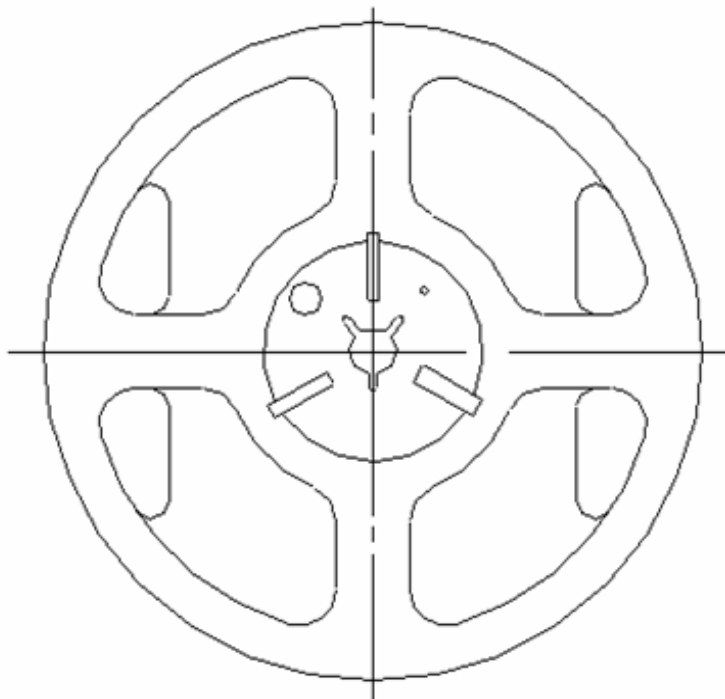

Unit:mm

Q'ty:1000pcs/reel