

## COY Series Ceramic SMD Oscillator

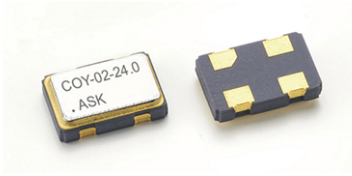

- Ceramic SMD package
- 1.8V to 5.0V supply voltage
- HCMOS/TTL Output
- Stability to  $\pm 10\text{ppm}$
- Suitable for reflow soldering

### PART NUMBER GUIDE

**COY-02A - 10.0 - 20 - B - S**

#### PACKAGE TYPE

- COY-05 : SMD - 5.0x3.2x1.3mm (5.0V)
- COY-03 : SMD - 5.0x3.2x1.3mm (3.3V)
- COY-03A : SMD - 5.0x3.2x1.3mm (3.0V)
- COY-03M : SMD - 5.0x3.2x1.3mm (1.8V ~3.3V)
- COY-02 : SMD - 5.0x3.2x1.3mm (2.5V)
- COY-02A : SMD - 5.0x3.2x1.3mm (2.8V)**
- COY-01 : SMD - 5.0x3.2x1.3mm (1.8V)

#### FREQUENCY

1.000MHz~156.000MHz

#### PIN 1 CONNECTION

**S : TRI-STATE, E/D**  
Blank : No Connection

#### OPERATING TEMPERATURE

**A : -40°C to +85°C**  
**B : -20°C to +70°C**  
**C : -10°C to +70°C**  
**D : 0°C to +70°C**

#### FREQUENCY STABILITY

**20 :  $\pm 20\text{ppm}$**

### ELECTRICAL SPECIFICATIONS

| MODEL                                   | COY-02A                        |
|---|--------------------------------|
| Frequency Range                         | 10.00MHz (AT Cut, Fundamental) |
| Frequency Tolerance / Stability         | $\pm 20\text{ppm}$             |
| Operating Temperature Range             | -20°C to +70°C                 |
| Storage Temperature Range               | -55°C to +125°C                |
| Supply Voltage (VDD)                    | 2.8V $\pm 10\%$                |
| Current consumption                     | 8mA Max.                       |
| Load                                    | 15pf                           |
| Output Level                            | CMOS                           |
| Output Voltage Logic High (VOH)         | 0.9VDD Min.                    |
| Output Voltage Logic Low (VOL)          | 0.1VDD Max.                    |
| Start up Time                           | 5ms Max.                       |
| Rise / Fall Time                        | 5ns Max.                       |
| Output Symmetry                         | 45~55 % (at 50% VDD)           |
| Phase jitter (integrated 10KHz ~ 20Mhz) | 1ps RMS                        |
| Peak to peak jitter                     | 50ps Max                       |
| Aging (at 25°C)                         | $\pm 3\text{ppm/ year Max}$    |
| Min. Packing                            | 1000pcs/ Reel                  |

MECHANICAL DIMENSION

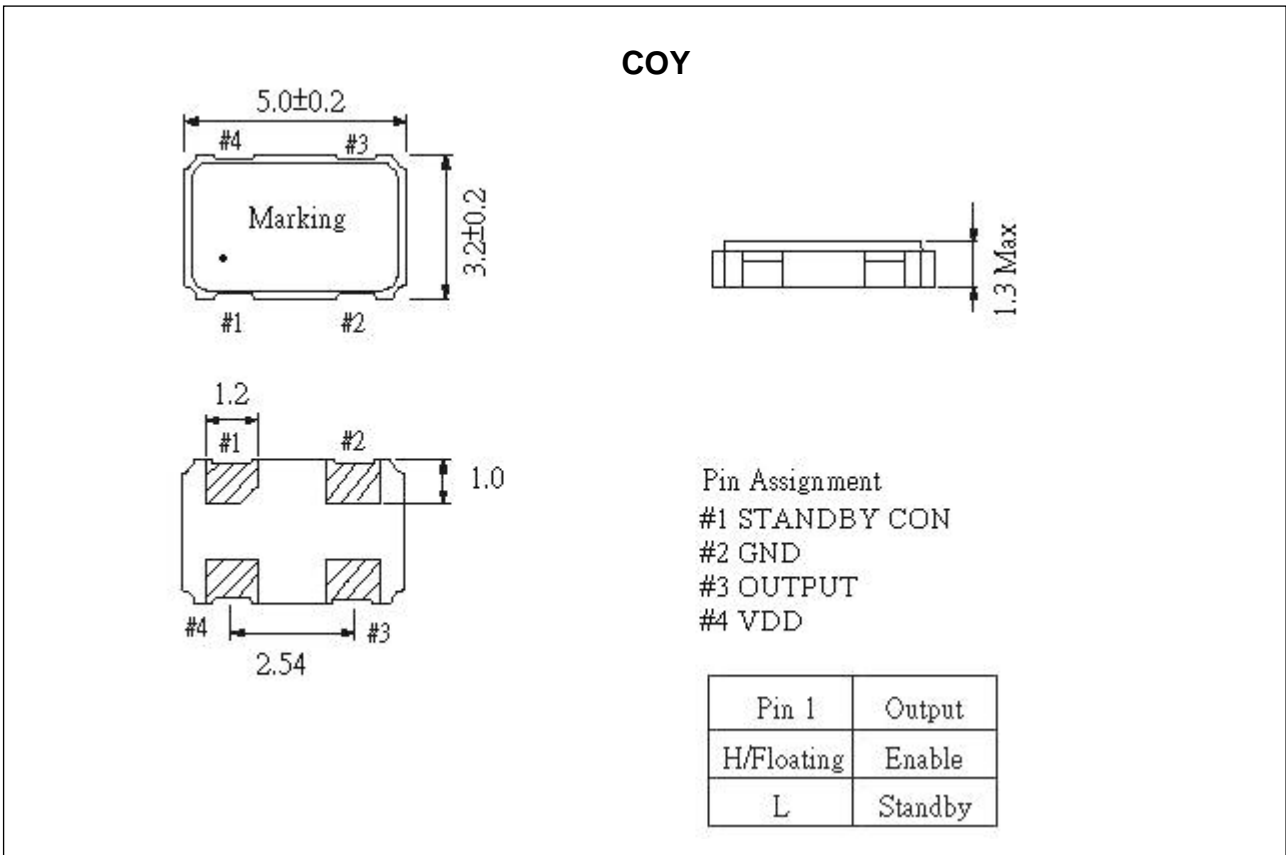

TEST CIRCUIT

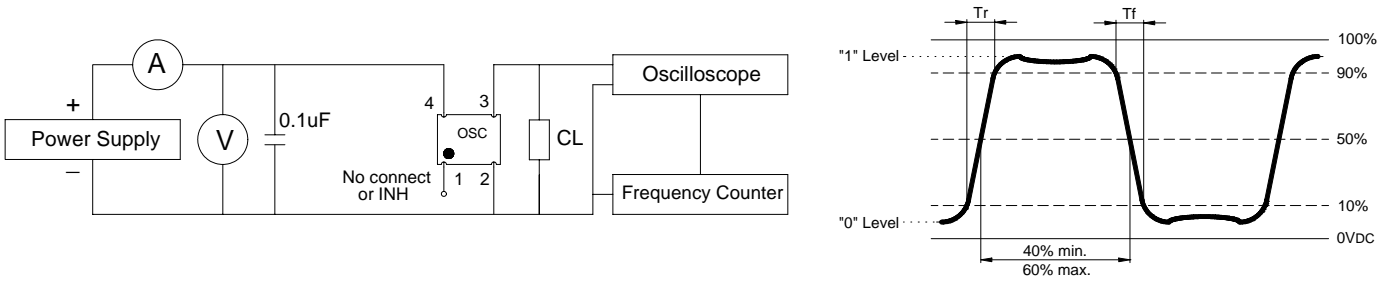

## SPECIFICATION OF CRYSTAL OSCILLATOR

### Soldering reflow

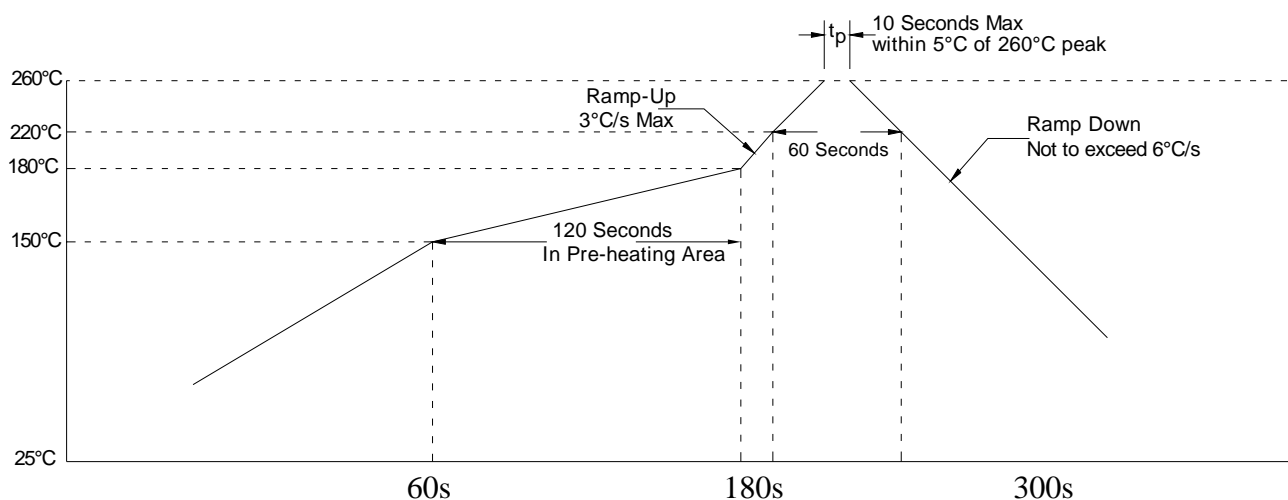

### Pb-free compliance

Component and Assembly Pb content shall be less than 0.1% by weight of the device (in accordance with IPC/EIA J-STD-006, European ROHS 3 Directive (EU) 2015/865).

### Product Information

For a product to be **RoHS** compliant, it must satisfy several conditions:

- Contain no more than the specified limits of the target hazardous substances set out in the RoHS Directive
- Able to withstand Pb-free 260°C solder reflow profile below
- External packaging and terminations are Pb-free
- Internal PCB, components, solders, and terminations are Pb-free

### EACH Regulation (EC) 1907/2006

Above concerned part is compliant with all requirement in the REACH regulations EC No. 1907/2006.

|  |
|--|
| <b>SPECIFICATION OF CRYSTAL OSCILLATOR</b> |
|--|

**Reliability Test** ( applicable to OSC and SMD type X'tal )

| Test Items                      | Test Condition  | Specification   |  |
|---------------------------------|---|---|--|
|                                 |   | General OSC (Note:1)  | General X' tal (Note:2)  |
| 1. Gross Leak Test              | FC-40 125°C/30sec   | No continuous bubble  |  |
| 2. Fine Leak Test               | Bombing of He 5kg/cm <sup>2</sup> for 2 hours   | Less than 1*10 <sup>-8</sup> atm.c.c./sec, Helium                                       |  |
| 3. Drop Test                    | Free dropped<br>a. ~19.999MHz(Fund.) →100 cm height<br>b. 20~29.999MHz(Fund.) →50 cm height<br>c. 30~ MHz(Fund.) →20 cm height<br>on a hard wooden board for 3 times<br>( board is thickness more than 30 mm) | $\Delta F \leq \pm 10\text{PPM}$ ,<br>Duty within spec.                                 | $\Delta F \leq \pm 10\text{PPM}$ ,<br>$\Delta C.I. \leq \pm 10\text{ohms}$ |
| 4. Vibration Test               | Freq. range: 10~55Hz<br>Peak to peak amplitude:1.5mm<br>Peak acceleration:10 G<br>3 direction(X,Y,Z) , each 60min.  | $\Delta F \leq \pm 10\text{PPM}$ ,<br>Duty within spec.                                 | $\Delta F \leq \pm 10\text{PPM}$ ,<br>$\Delta C.I. \leq \pm 10\text{ohms}$ |
| 5. Resistance to Soldering Test | a. IR Reflow furnace with the condition 2 times. Peak temp. 260±3°C , 10sec( Min.)  | $\Delta F \leq \pm 10\text{PPM}$ ,<br>Duty within spec.<br>For SMD OSC only             | $\Delta F \leq \pm 10\text{PPM}$ ,<br>$\Delta C.I. \leq \pm 10\text{ohms}$ |
|                                 | b. Dip terminals in a 260±5°C solder bath for 5±0.5 sec.  | At least 90% of each dipped area shall be covered by fresh solder.<br>For DIP OSC only. | NA   |
| 6. Bending Test                 | Bending cycle : 1 cycle<br>0° -> 45° -> 0° -> 45° -> 0°   | $\Delta F \leq \pm 5\text{PPM}$ ,<br>Duty within spec.<br>For DIP OSC only.             | NA   |
| 7. Share Test                   | Weight : 10N,<br>Test duration : 10±1 sec   | $\Delta F \leq \pm 5\text{PPM}$ ,<br>Duty within spec.<br>For SMD OSC only.             | $\Delta F \leq \pm 10\text{PPM}$ ,<br>$\Delta C.I. \leq \pm 10\text{ohms}$ |
| 8. Low Temp. Exposure Test      | -40±3°C, 240±12 hrs   | $\Delta F \leq \pm 10\text{PPM}$ ,<br>Duty within spec.                                 | $\Delta F \leq \pm 10\text{PPM}$ ,<br>$\Delta C.I. \leq \pm 10\text{ohms}$ |
| 9. Aging Test                   | 125±3°C, 240±12hrs  | $\Delta F \leq \pm 10\text{PPM}$ ,<br>Duty within spec.                                 | $\Delta F \leq \pm 10\text{PPM}$ ,<br>$\Delta C.I. \leq \pm 10\text{ohms}$ |
| 10. High Temp. & Humidity Test  | +85°C±5°C & 85%±5% R.H. , 240±12 hrs  | $\Delta F \leq \pm 10\text{PPM}$ ,<br>Duty within spec.                                 | $\Delta F \leq \pm 10\text{PPM}$ ,<br>$\Delta C.I. \leq \pm 10\text{ohms}$ |
| 11. Temperature Cycling Test    | -40±3°C/15±3min ~ +85±3°C/15±3min<br>15cycles   | $\Delta F \leq \pm 10\text{PPM}$ ,<br>Duty within spec.                                 | $\Delta F \leq \pm 10\text{PPM}$ ,<br>$\Delta C.I. \leq \pm 10\text{ohms}$ |

Note:1 → For communication application the spec. demanded " $\Delta F \leq \pm 5\text{ PPM}$ , Duty within spec." .

Note:2 → For communication application the spec. demanded " $\Delta F \leq \pm 5\text{ PPM}$ ,  $\Delta C.I. \leq \pm 5\text{ ohms}$ " .

SPECIFICATION OF TAPE & REEL

Taping

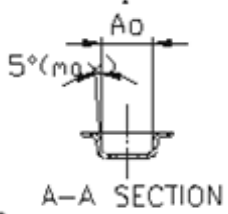
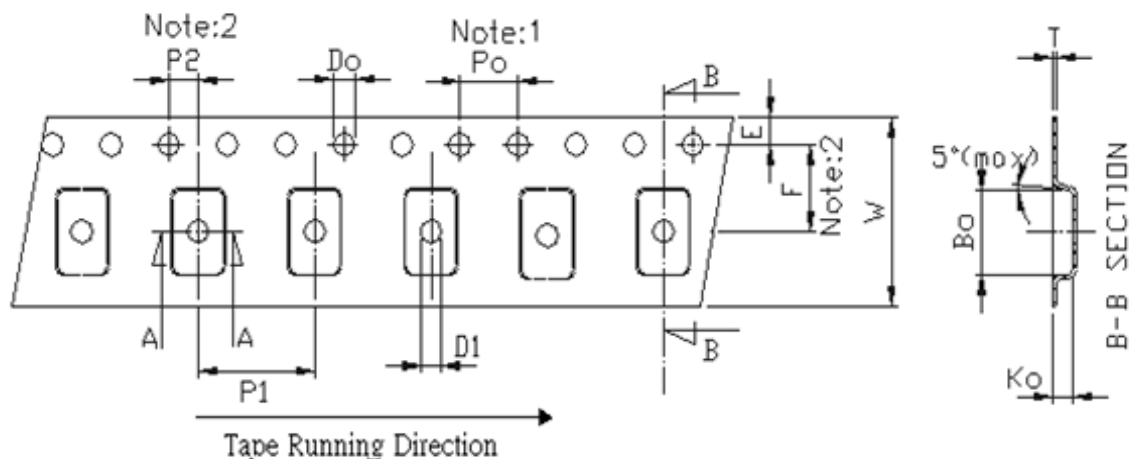

$$A_o = \frac{3.50 \pm 0.10}{\text{mm}}$$

$$B_o = \frac{5.25 \pm 0.10}{\text{mm}}$$

$$K_o = \frac{1.40 \pm 0.10}{\text{mm}}$$

Unit: mm

| Symbol | Spec.       |
|--------|-------------|
| K1     | -           |
| Po     | 4.0 ± 0.10  |
| P1     | 8.0 ± 0.10  |
| P2     | 2.0 ± 0.05  |
| Do     | 1.55 ± 0.05 |
| D1     | 1.50 (MIN)  |
| E      | 1.75 ± 0.10 |
| F      | 5.50 ± 0.05 |
| 10Po   | 40.0 ± 0.10 |
| W      | 12.0 ± 0.20 |
| T      | 0.30 ± 0.05 |

Notice:

- 1.10 Sprocket hole pitch cumulative tolerance is ±0.1mm
2. Pocket position relative to sprocket hole measured as true position of pocket not pocket hole.
3. Ao & Bo measured on a plane 0.3mm above the bottom of the pocket to top surface of the carrier.
4. Ko measured from a plane on the inside bottom of the pocket to the top surface of the carrier.
5. Carrier camber shall be not than 1mm per 100mm through a length of 250mm.

SPECIFICATION OF TAPE & REEL

Reel

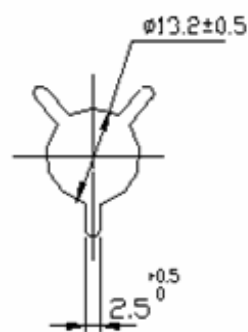
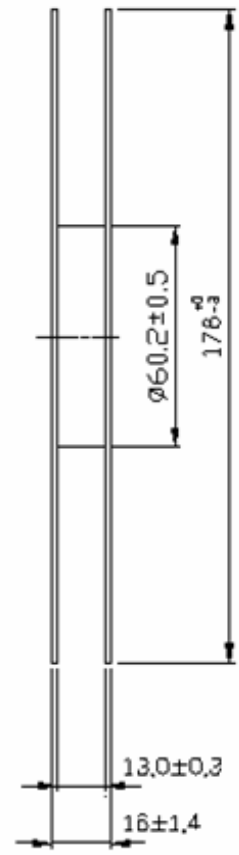
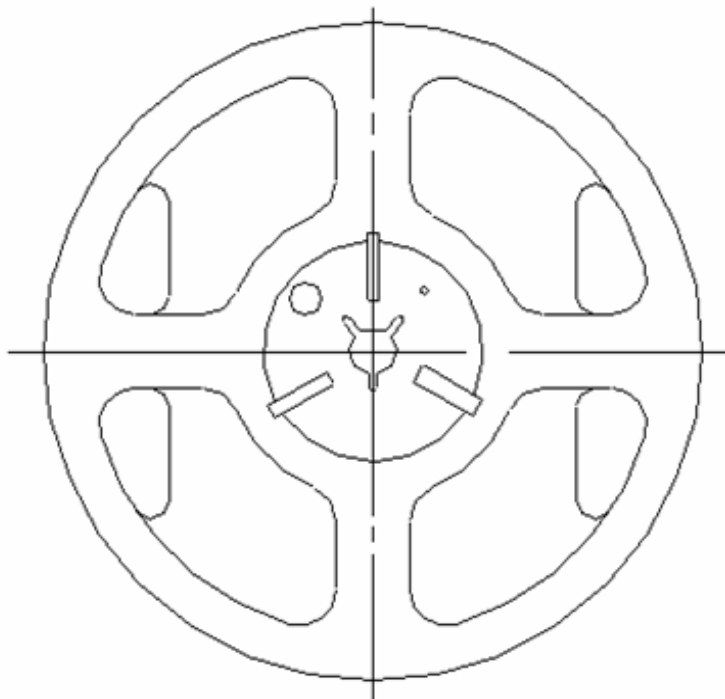

Unit:mm

Q'ty:1000pcs/reel